

falken°hr
home of music

317

Much more than just a Hi-Fi rack.

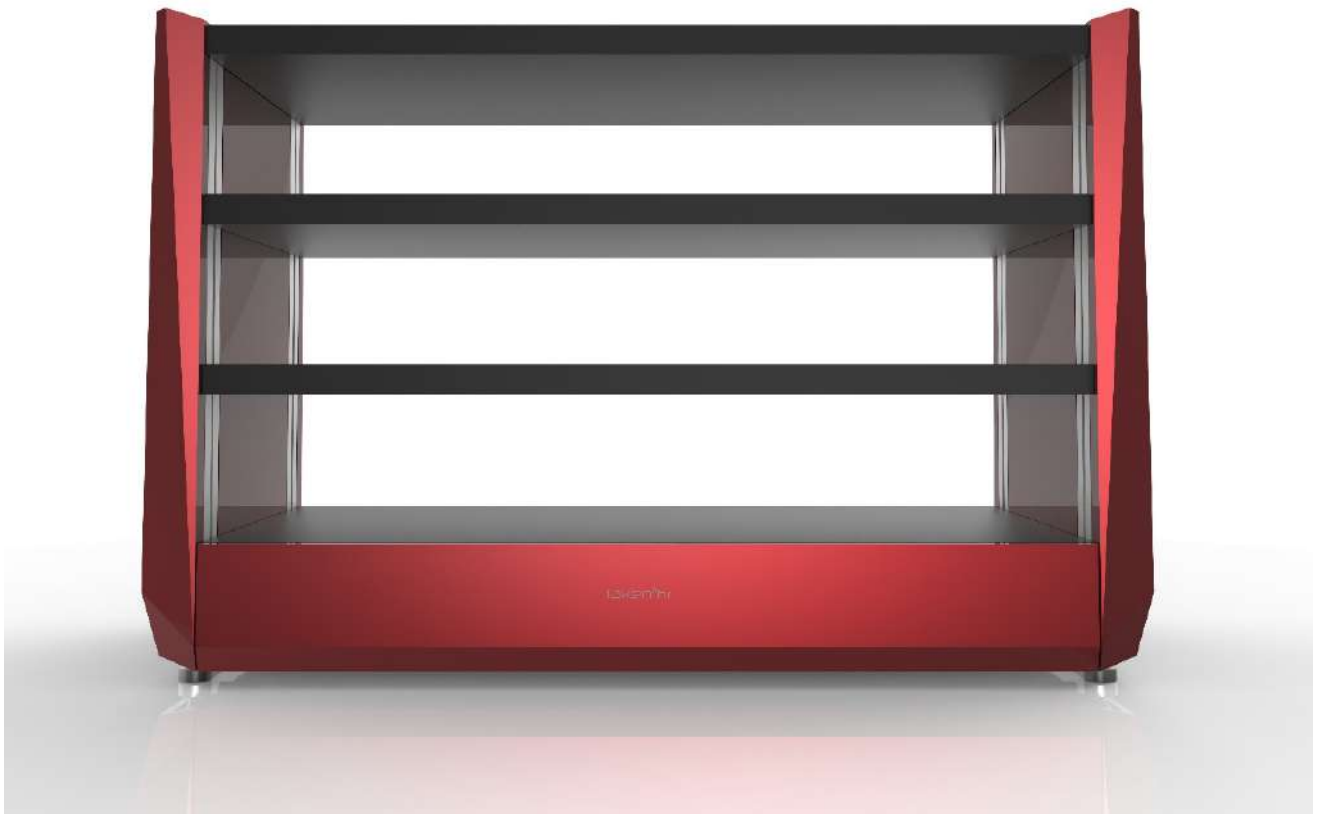

Table of contents

3 Overview 317 – Klangmöbel¹ and Klangbasen² – Standard and optional equipment

KLANGMÖBEL¹ GENIUM LINE and PURE LINE

4	Genium Line
6	Pure Line
8	Basic models with prices
8	Genium Line
8	Pure Line
9	Standard equipment
9	Technology
10	Equipment Sound-core and Functional-body
13	Cladding
13	Accessories
14	Optional equipment
14	Equipment
15	Cladding
15	Packaging

16	Surface finishing
16	Shelves
17	Cladding
18	Dimensions
18	Genium Line
20	Pure Line

KLANGBASEN² BASE LINE

22	Base Line
23	Basic models with prices
23	Base Line
24	Standard equipment
24	Technology
25	Equipment Sound-Core and Stability-Core
26	Cladding
26	Accessories
27	Optional equipment
27	Cladding
27	Packaging
28	Surface finishing
28	Shelves
29	Cladding
30	Dimensions
30	Base Line
31	Warranty
32	Explanations

Overview 317

Standard and Extras

Genium Line	Pure Line	Base Line
-------------	-----------	-----------

DESIGN

Crystal	●	●	●
Classic	○	○	○

WIDTH

Single width ³	●	●	●
Double width ³	●	●	-
Triple width ³	●	●	-

DESIGN HEIGHT

166 mm	-	-	●
650 mm	●	●	-
775 mm	●	●	-
900 mm	●	●	-
1025 mm	●	●	-

TECHNOLOGY

Compound shelves	●	●	●
3D/10 Technology – vibrations decoupling	●	●	●
3D/10 Technology – electromagnetic decoupling	●	●	●
Sound adjustment	●	●	●
Adjustable shelves	●	●	-
Decoupling of the functional parts	●	●	●
Stability core with damping concrete	-	-	●

EQUIPMENT

Drawer	●	●	-
Rollers	●	●	-
Cable installation area with strain relief and cable inlet	●	-	-
Pendulum flaps	○	-	-
Pluggable rear panel	●	-	-
Power strip	○	-	-
Decoupled Base	○	○	-
Assembly tools and instruction manual	●	●	●



Genium Line

Designed for consummate listening enjoyment in a residential setting. The Genium Line has it all, high-quality sound, a sophisticated design – and features never before seen in audio furniture. The world of FalkenOhr for true audiophiles.





integrated

Genium Line

Equipped with a cable installation area, drawer, claddings, and a rear panel.





Pure Line

Made for purists. The focus is on sound and design. Reduced to their essence. Purism for high demands.





Pure Line

Equipped with drawer and cladding.

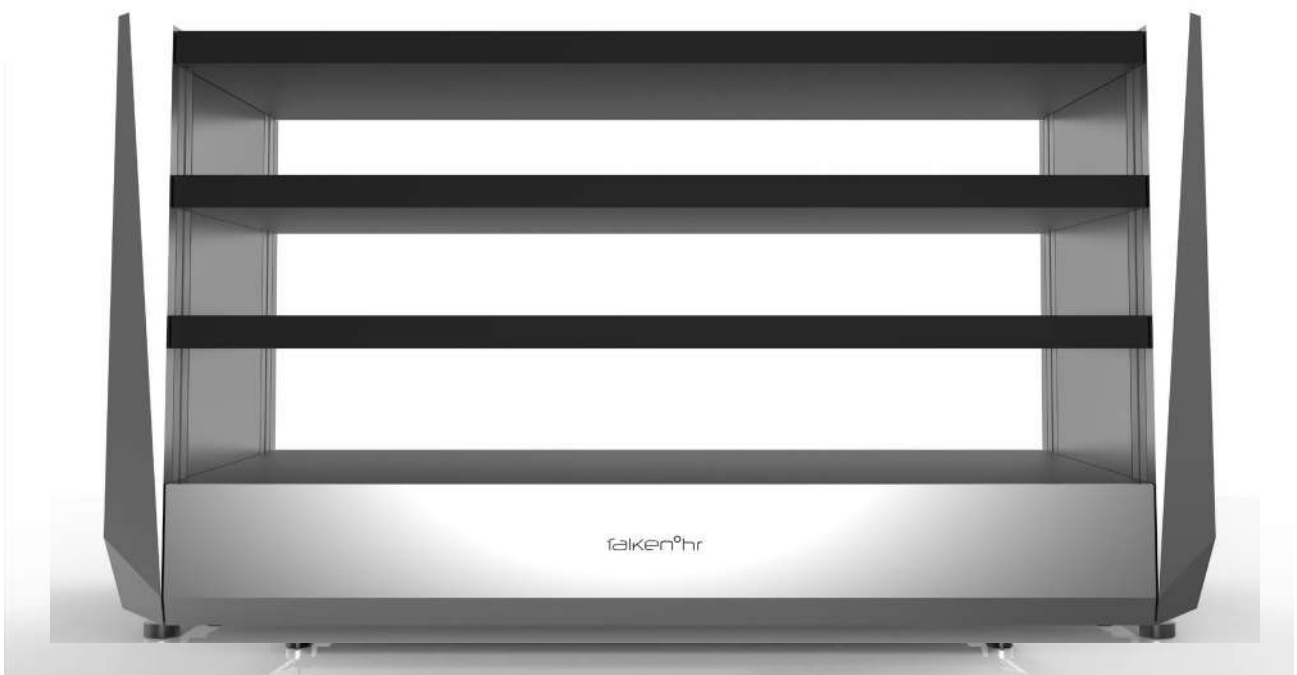

Basic models 317

Genium Line and Pure Line

Height in mm	Design-width	Width in mm	Shelf-width in mm	Shelves in pcs	Weight ⁴ in kg	List price ⁵ Euro excl. VAT
317 Genium Line						
650	single width	698	560	3	104,5	
775	single width	698	560	3	114,0	
900	single width	698	560	3	123,0	
1025	single width	698	560	3	133,0	
650	double width	1178	1040	3	146,0	
775	double width	1178	1040	3	158,0	
900	double width	1178	1040	3	170,5	
1025	double width	1178	1040	3	181,0	
650	triple width	1698	1560	3	189,0	
775	triple width	1698	1560	3	201,5	
900	triple width	1698	1560	3	213,5	
1025	triple width	1698	1560	3	226,5	
317 Pure Line						
650	single width	698	560	3	85,0	
775	single width	698	560	3	91,5	
900	single width	698	560	3	98,0	
1025	single width	698	560	3	104,5	
650	double width	1178	1040	3	117,5	
775	double width	1178	1040	3	124,0	
900	double width	1178	1040	3	130,5	
1025	double width	1178	1040	3	137,0	
650	triple width	1698	1560	3	151,5	
775	triple width	1698	1560	3	158,0	
900	triple width	1698	1560	3	164,5	
1025	triple width	1698	1560	3	171,0	

Standard equipment 317

Genium Line and Pure Line

List price⁵
Euro excl. VAT.

Genium Line

Pure Line

TECHNOLOGY

Compound-Shelves	Multi-layer structure made of MDF and aluminum with a special adhesive.		●	●
3D/10 Technology – vibrations decoupling	<p>For us, the art of a dynamic sound image lies in deriving micro-vibrations in the best possible way and damping them as little as possible. The new, innovative connections of the FalkenOhr shelves to the stands are either damping or conductive. This enables the micro-vibrations generated by the audio devices in one shelf to be dissipated without disturbing the other levels.</p> <p>Your benefit: The micro-vibrations of the electronics are dissipated in a targeted and extremely fast manner and the devices are decoupled from each other, this leads to a highly dynamic and precise sound image.</p>		●	●
3D/10 Technology – electromagnetic decoupling	<p>The aluminum layers make it possible to discharge and shorten the voltage induced by the electromagnetic fields of the audio components. Therefore, the electromagnetic interference between two layers is drastically reduced.</p> <p>Your benefit: The reduced interferences lead to a significant increase in precision and clarity of sound.</p>		●	●
Sound adjustment - analytic/warm	<p>Adjustment of the sound image to your acoustic preferences and conditions by adjustable damping of the spike shoes. Stone floors, certain audio components, or living room conditions can create a too hard, rigid, or even over-analytical sound. Therefore, it is possible to insert a plastic ring into the floor plate. Otherwise, the stainless-steel floor plate rests directly on the floor. The damping can be adjusted individually for each stand, and this results in a different damping/coupling for each shelf.</p>		●	●
Shelves can be rearranged in a grid of 25 mm	Each shelf can be rearranged individually at any time in a 25 mm grid.		●	●

Standard equipment 317

Genium Line and Pure Line

		List price ⁵ Euro excl. VAT.	Genium Line	Pure Line
<p>Clear structure</p>  <p>FalkenOhr audio furniture has a clear structural separation into three main structural components. These are independently mounted and decoupled from each other.</p> <p>SOUND CORE The heart of your audio furniture. Designed for an extremely clear, powerful, and spatial sound image.</p> <p>FUNCTIONAL BODY More than just a rack, the additional possibilities, and functionality for your audio furniture. Developed for your living area and your high-end audio components.</p> <p>CLADDING The beautiful cover for your audio furniture</p>			●	●
<p>Decoupling of attachments</p>	<p>All parts attached to the sound core are made of damping material on the one hand and are decoupled by a specially molded thermoplastic material as a connecting element on the other hand. This plastic, which is also used especially in mechanical engineering, is characterized by its high degree of homogeneity and thus uniform damping properties with high strength.</p>		●	●

10



EQUIPMENT

SOUND-CORE

<p>Stands incl. spikes 4 pcs.</p> 	<p>Made of highly homogenous, cast aluminum EN AW-5083 in natural E6 / CO anodized.</p> <p>Raw aluminum is rather soft and therefore absorbs resonances well and can distribute and transmit them very evenly due to its ordered microstructure. When the surface is finished with anodizing, a hard layer is created which makes the aluminum resistant and at the same time very conductive to sound. This enables extremely fast transmission of vibrations and resonances and at the same time a certain and desired damping. This combination cannot be found in any other material in such a balanced way.</p> <p>Spikes made of stainless steel 1.4305</p>		●	●
--	---	--	---	---



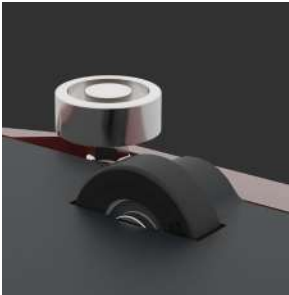

Standard equipment 317

Genium Line and Pure Line

		List price ⁵ Euro excl. VAT.	Genium Line	Pure Line
<p>Shelves 3 pcs.</p> 	<p>Composite shelves with innovative integrated connection technology.</p> <p>A shelf is conductively connected to exactly one stand and insulated with the other 3 stands, thereby vibrations from one shelf cannot influence any other shelves. This leads to the perfect transmission of the micro-vibrations created by the electronics and to the high stiffness of the sound-core</p>		●	●
<p>Spike shoes 4 pcs.</p> 	<p>Ground plate milled out of stainless steel 1.4305. Optional plastic ring made of highly damping molded polyamide which has a high mechanical load capacity and good damping characteristics</p>		●	●
FUNCTIONAL-BODY				
<p>Drawer 1 pc.</p> 	<p>A drawer on the underside of the rack. Optimal storage space for your Hifi accessories. The drawer opens and closes quietly and effortlessly with a gentle tap. Vibration technically decoupled from the sound core.</p> <ul style="list-style-type: none"> • TIP-ON BLUMOTION⁶ fittings • Drawer made of MDF • exclusive flocked inlay mat against shifting 		●	●
<p>Rollers 4 pcs.</p> 	<p>The rack is set up and positioned on spikes with a ground plate in the normal mode. When the spikes are turned to their zero position, the audio furniture stands on floor-protecting rollers. This enables an easy and gentle movement on your floors</p> <ul style="list-style-type: none"> • 4 pcs. Rollers with thermoplastic polyurethane tread, with ball bearings <p>Your benefit: Easy movement of the rack with audio devices inside, nevertheless without damaging the</p>		●	●



Standard equipment 317

Genium Line and Pure Line

		List price ⁵ Euro excl. VAT.	Genium Line	Pure Line
Cable-Installation-Area		<p>Separate, easily accessible room for your cable installation. Designed for orderly arrangement and mounting of the signal and electrical cables. Suitable for cable diameters up to 20 mm and plug diameters up to 42 mm. Completely decoupled from the sound core.</p> <p>Your benefit: "Invisible" cable installation, protection against dust, and easy cleaning.</p>	●	-
Strain relief rails 2 pcs.		<p>Strain relief rails made of anodized aluminum within the installation level for fixing the cables. The strain relief rails can be implemented in a grid of 25 mm without tools.</p> <p>Your benefit: Clean and orderly cable installation. Decoupled from the sound core.</p>	●	-
Decoupling the cables		<p>For cable diameters of 6-20 mm. O-rings for fixing the cables. The cables can vibrate freely in this bracket and are also decoupled from external mechanical oscillations and vibrations.</p> <p>Your benefit: minimizing external interference on the cabling and thus a clear improvement in the sound quality of your electronics.</p>	●	-
Cable inlet		<p>Pluggable cable inlet, made from aluminum EN AW-5083 in natural E6/CO anodized finish, with an integrated brush on top of the audio furniture.</p> <ul style="list-style-type: none"> ● 1 pcs. Cable inlet for single-width racks ● 2 pcs. Cable inlets for double-width racks ● 3 pcs. Cable inlets for triple-width racks <p>Your benefit: High-quality impression and protection of the audio furniture insides against dust.</p>	●	-

Standard equipment 317

Genium Line and Pure Line

		List price ⁵ Euro excl. VAT.	Genium Line	Pure Line
Rear Panel		<p>The back panel of each FalkenOhr audio furniture is pluggable, can be quickly removed, and is equipped with invisible air vents. It serves as a protection against dust and is also a pleasant visual finish to its back.</p>	●	-
CLADDING				
Design Crystal Cladding incl. decoupling		<p>Made of damping MDF.</p> <p>The beautiful cover for your audio furniture. Designed to complete the visual delight. Apart from the aesthetic appearance, the clarity of the sound is further enhanced due to the mass and the shielding of the audio devices from external influences.</p> <p>Decoupled from the sound core.</p>	●	●
ACCESSORIES				
Assembly tools and instruction manual		<p>Complete accessories for perfect installation and optimization of your audio furniture. Range depending on the model selected:</p> <ul style="list-style-type: none"> ● 4 pcs. spike shoes ● 4 pcs. Plastic inserts for ground plate ● 1 pc. Open-end wrench 22 ● 1 pc. Open-end wrench 13 ● 1 pc. circular bubble ● Allen wrench ● O-Rings ● White cotton glove ● Instruction manual 	●	●



Optional equipment 317

Genium Line and Pure Line

List price ⁵ Euro excl. VAT.	Genium Line	Pure Line
--	-------------	-----------

EQUIPMENT

SOUND-CORE

<p>Additional shelf 1 pc.</p> 	<p>Composite shelves with innovative integrated connection technology.</p>	<p>Single width Double width Triple width</p>		○	○
<p>Decoupled Base 1 pc.</p> 	<p>For each desired position, a 12 mm thick aluminum plate (EN AW-5083, natural E0/C6 anodized) is inserted into the shelf and supported on 3 spikes with spike shoes. These are made of stainless steel 1.4305.</p> <p>The maximum sound solution through additional mass and decoupling, optionally for one or more levels.</p> <p>Your benefit: Maximum decoupling of the electronics from the environment and each other. Therefore you get the highest possible precision in sound.</p>			○	○

FUNCTIONAL-BODY

<p>Pendulum flaps 3 pcs.</p> 	<p>Lockable pendulum flaps between the device and the installation area. These enable easy installation and can be adjusted in height in a 25 mm grid to the position of the shelves.</p> <p>Your benefit: Once the installation is complete, only narrow slots remain between the device and installation levels. From the front of the furniture, you can see virtually nothing of the cabling.</p>	<p>650 single-width 775 single-width 900 single-width 1025 single-width 650 double-width 775 double-width 900 double-width 1025 double-width 650 triple-width 775 triple-width 900 triple-width 1025 triple-width</p>		○	-
---	--	---	--	---	---

Optional equipment 317

Genium Line and Pure Line

		List price ⁵ Euro excl. VAT.	Genium Line	Pure Line
Power Strip 1 pc. 	Power-Strip 7-fold ^{*/7} Power-Strip 11-fold ^{**/7} Perfect, clear sound through a stable integrated power supply. <ul style="list-style-type: none"> • CNC machined 11,6 mm thick anodized aluminum (EN AW-5083, nature E6/CO anodized) base plate for highest rigidity • direct stable integration into the functional frame allows channeling and damping of the vibrations (50/60Hz from the power grid) • FuruTech High Performance plugs 24k gold plated • FuruTech High-Performance IEC-Inlet 24k gold plated <p>Your benefit: Due to the power strip being perfectly integrated into the functional body, you achieve a minimum of natural oscillations of the power strip. Decoupled from the sound core.</p> <p>* for single-, double- and triple-width audio furniture ** for double-and triple width audio-furniture</p>		○ ○	- -

15

CLADDING

Design Classic Cladding incl. decoupling 	Made of damping MDF. The beautiful cover for your audio furniture. Designed to complete the visual delight. Apart from the aesthetic appearance, the clarity of the sound is further enhanced due to the mass and the shielding of the audio devices from external influences. Decoupled from the sound core.		○	○
---	---	--	---	---

PACKAGING

Packaging 	Packed in a high-grade wooden box made of light, strength, and resistant Ceiba plywood. The lid of the box is clipped and removable.	Single width Double width Triple width	○	○
---	--	--	---	---





Surface finishing 317

Genium Line and Pure Line









Extra charge ⁵ per shelf Euro excl. VAT single width	Extra charge ⁵ per shelf Euro excl. VAT double width	Extra charge ⁵ per shelf Euro excl. VAT triple-width	Genium Line	Pure Line
---	---	---	-------------	-----------

SHELVES

Lacquered finishes

	Black ⁸	<input type="checkbox"/> matt G30, slightly structured <input type="checkbox"/> semi-gloss G70				● ○	● ○
	Black ⁸	<input type="checkbox"/> high gloss G100 <input type="checkbox"/> high gloss G100, polished				- ○	- ○
	Arctic grey ⁸	<input type="checkbox"/> matt G30, slightly structured <input type="checkbox"/> semi-gloss G70				○ ○	○ ○
	Arctic grey ⁸	<input type="checkbox"/> high gloss G100 <input type="checkbox"/> high gloss G100, polished				○ ○	○ ○

Real wood veneers

	Maple ⁸	<input type="checkbox"/> matt G30 <input type="checkbox"/> semi-gloss G70				○ ○	○ ○
	Maple ⁸	<input type="checkbox"/> high gloss G100 <input type="checkbox"/> high gloss G100, polished				○ ○	○ ○
	Pear ⁸	<input type="checkbox"/> matt G30 <input type="checkbox"/> semi-gloss G70				○ ○	○ ○
	Pear ⁸	<input type="checkbox"/> high gloss G100 <input type="checkbox"/> high gloss G100, polished				○ ○	○ ○
	Makassar replica ⁸	<input type="checkbox"/> matt G30 <input type="checkbox"/> semi-gloss G70				○ ○	○ ○
	Makassar replica ⁸	<input type="checkbox"/> high gloss G100 <input type="checkbox"/> high gloss G100, polished				○ ○	○ ○
	Makassar ⁸	<input type="checkbox"/> matt G30 <input type="checkbox"/> semi-gloss G70				○ ○	○ ○
	Makassar ⁸	<input type="checkbox"/> high gloss G100 <input type="checkbox"/> high gloss G100, polished				○ ○	○ ○
	Teak ⁸	<input type="checkbox"/> matt G30 <input type="checkbox"/> semi-gloss G70				○ ○	○ ○

Individual surface finishing

Your desired finish ⁸ on request						○	○
---	--	--	--	--	--	---	---

Surface finishing 317

Genium Line and Pure Line











Extra charge ⁵ Euro excl. VAT Complete Cladding	Genium Line	Pure Line

CLADDING

Lacquered finishes

	Black ⁸	<input type="checkbox"/> matt G30 - soft touch <input type="checkbox"/> semi-gloss G70		● ○	● ○
	Black ⁸	<input type="checkbox"/> high gloss G100 <input type="checkbox"/> high gloss G100, polished		- ○	- ○
	Pure white ⁸	<input type="checkbox"/> matt G30 – soft touch <input type="checkbox"/> semi-gloss G70		● ○	● ○
	Pure white ⁸	<input type="checkbox"/> high gloss G100 <input type="checkbox"/> high gloss G100, polished		○ ○	○ ○

Metallic finishes

	Silver metallic ⁸	<input type="checkbox"/> matt G30 – soft touch		○	○
	Silver metallic ⁸	<input type="checkbox"/> high gloss G100 <input type="checkbox"/> high gloss G100, polished		○ ○	○ ○
	Arctic grey metallic ⁸	<input type="checkbox"/> matt G30 – soft touch		○	○
	Arctic grey metallic ⁸	<input type="checkbox"/> high gloss G100 <input type="checkbox"/> high gloss G100, polished		○ ○	○ ○
	Luxor metallic ⁸	<input type="checkbox"/> matt G30 – soft touch		○	○
	Luxor metallic ⁸	<input type="checkbox"/> high gloss G100 <input type="checkbox"/> high gloss G100, polished		○ ○	○ ○
	Crystal Red metallic ⁸	<input type="checkbox"/> matt G30 – soft touch		○	○
	Crystal Red metallic ⁸	<input type="checkbox"/> high gloss G100 <input type="checkbox"/> high gloss G100, polished		○ ○	○ ○
	Deep Crystal Blue metallic ⁸	<input type="checkbox"/> matt G30 – soft touch		○	○
	Deep Crystal Blue metallic ⁸	<input type="checkbox"/> high gloss G100 <input type="checkbox"/> high gloss G100, polished		○ ○	○ ○

Individual surface finishing

Your desired finish ⁸ on request		○	○
---	--	---	---

Dimensions 317

Single width

Double width

Triple width

317 Genium Line

Design height 650 mm ⁹

Usable height 447 mm. The shelves can be adjusted in height in a grid of 25 mm. Shelf-thickness 34 mm. Max. 4 shelf levels.

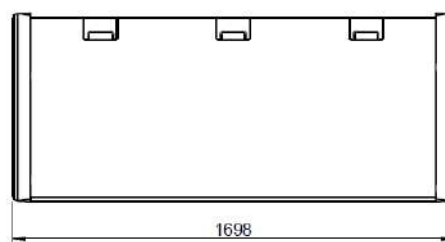
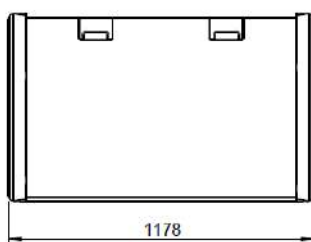
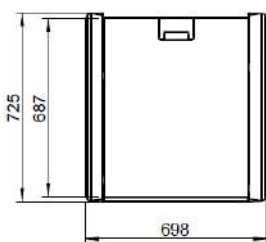
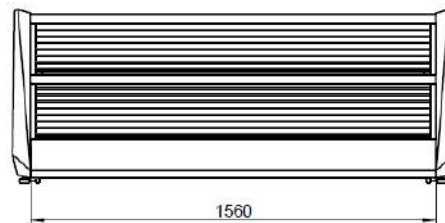
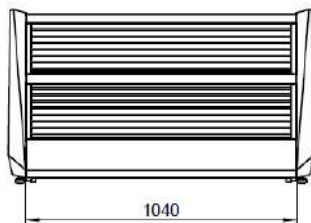
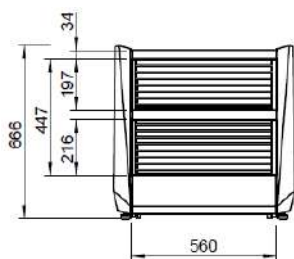

Design height 775 mm ¹⁰

Usable height 572 mm. The shelves can be adjusted in height in a grid of 25 mm. Shelf-thickness 34 mm. Max. 4 shelf levels.

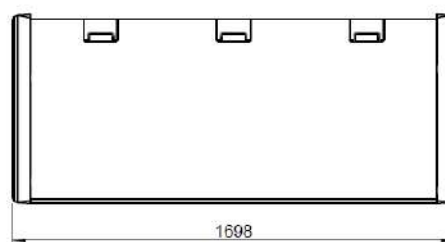
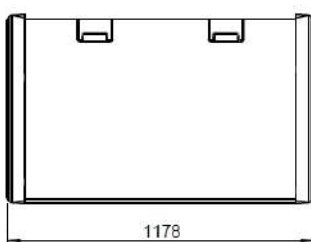
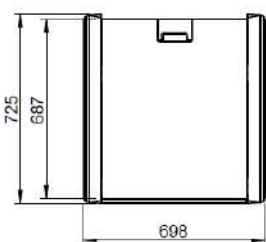
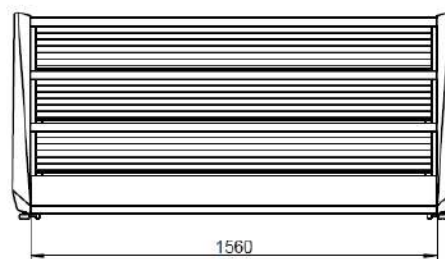
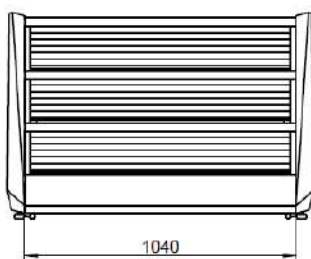
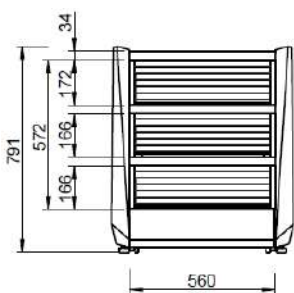

Single width

Double width

Triple width

Design height 900 mm ¹⁰

Usable height 697 mm. The shelves can be adjusted in height in a grid of 25 mm. Shelf-thickness 34 mm. Max. 5 shelf levels.

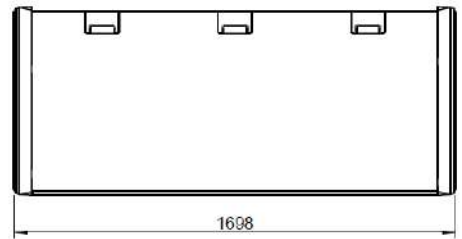
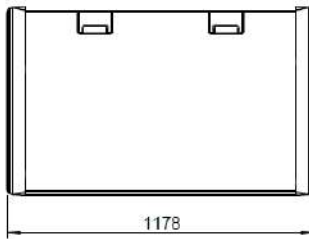
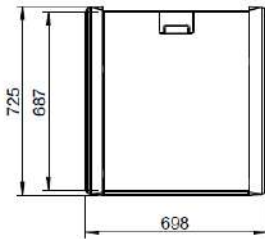
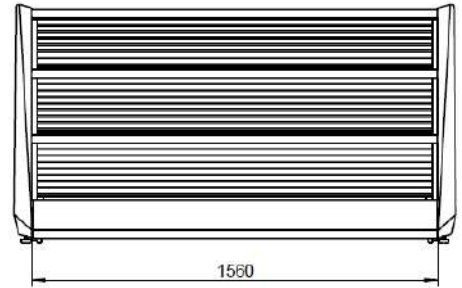
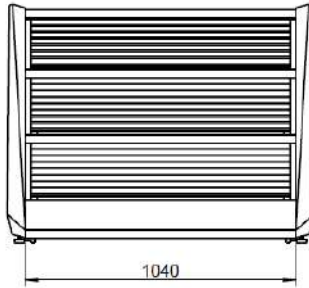
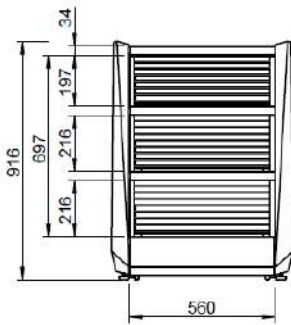

Design height 1025 mm ¹⁰

Usable height 822 mm. The shelves can be adjusted in height in a grid of 25 mm. Shelf-thickness 34 mm. Max. 5 shelf levels.

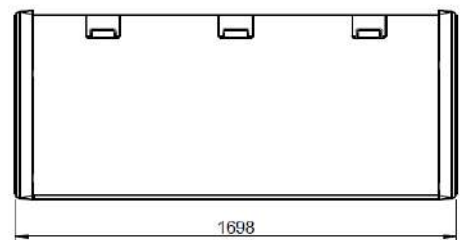
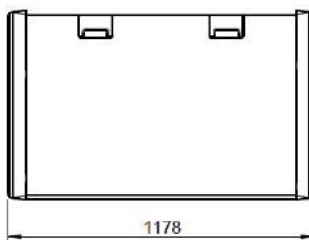
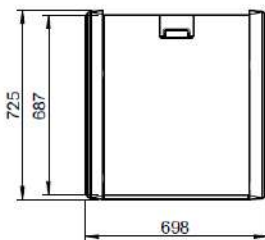
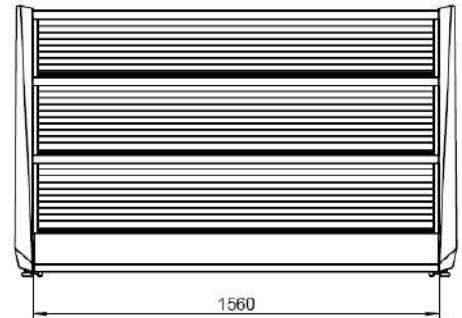
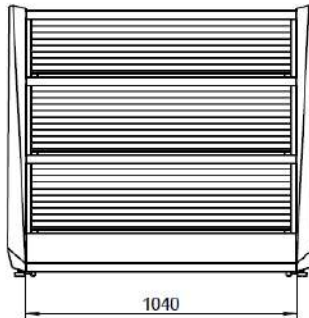
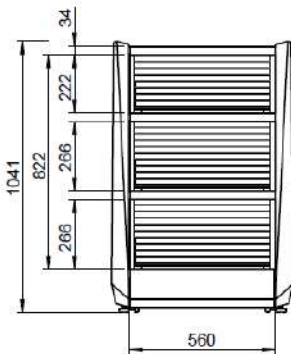

Single width

Double width

Triple width

317 Pure Line

Design height 650 mm

Usable height 447 mm. The shelves can be adjusted in height in a grid of 25 mm. Shelf-thickness 34 mm. Max. 4 shelf levels.

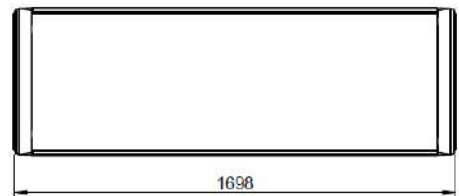
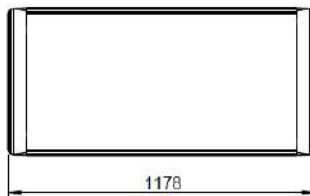
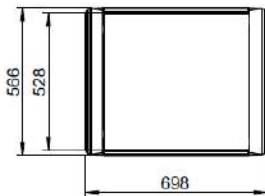
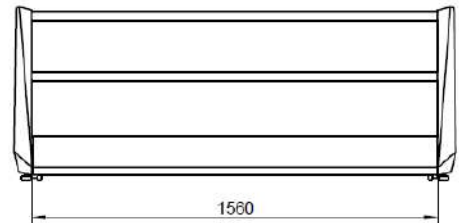
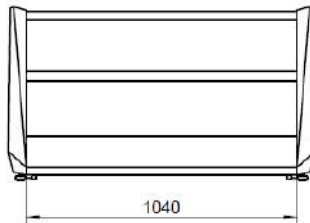
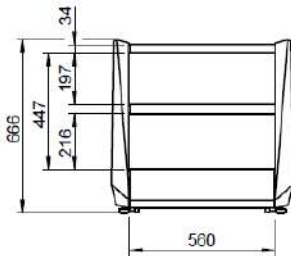

20

Design height 775 mm ¹¹

Usable height 572 mm. The shelves can be adjusted in height in a grid of 25 mm. Shelf-thickness 34 mm. Max. 4 shelf levels.

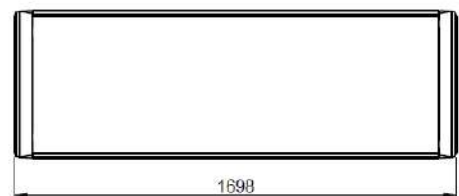
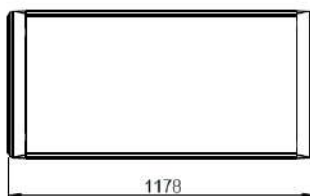
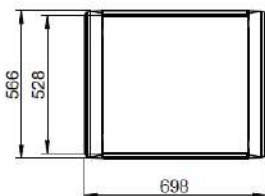
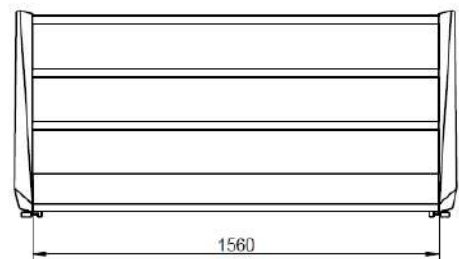
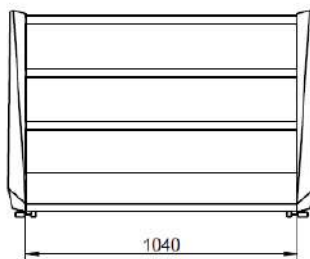
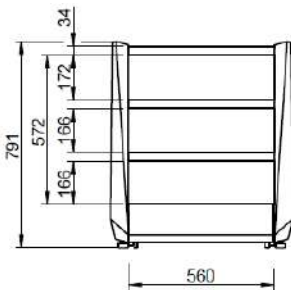

Single width

Double width

Triple width

Design height 900 mm ¹¹

Usable height 697 mm. The shelves can be adjusted in height in a grid of 25 mm. Shelf-thickness 34 mm. Max. 5 shelf levels.

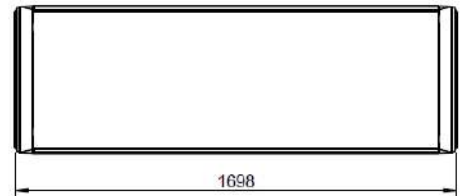
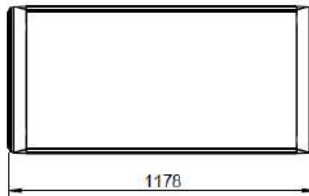
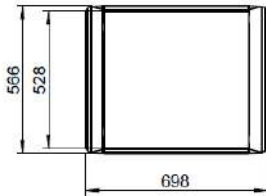
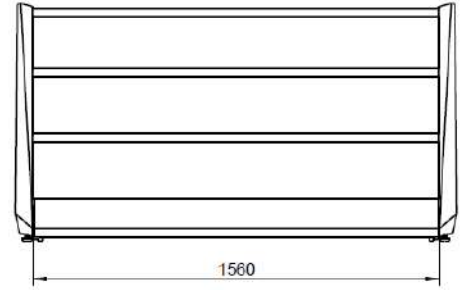
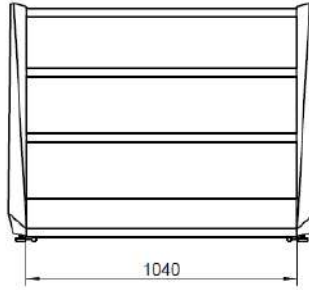
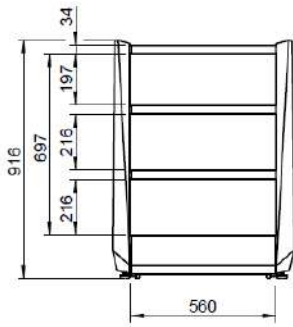

Design height 1025 mm ¹¹

Usable height 822 mm. The shelves can be adjusted in height in a grid of 25 mm. Shelf-thickness 34 mm. Max. 5 shelf levels.

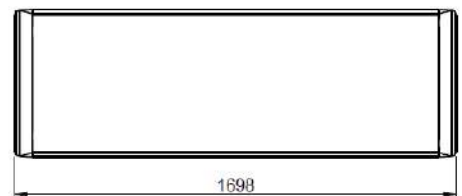
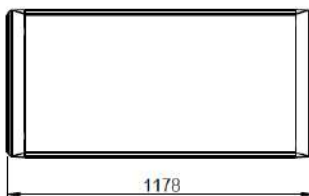
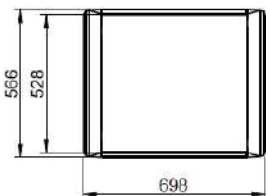
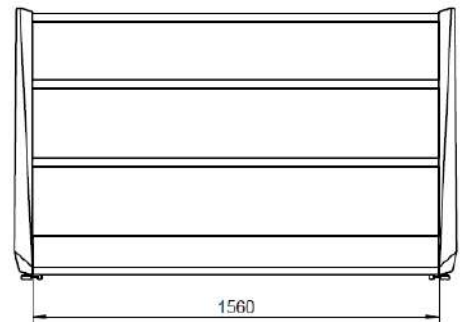
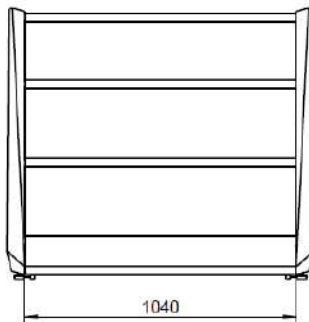
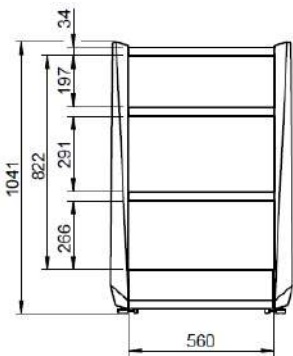



Base Line

The base for your power amps and/or speakers. Created as an ideal complement to Pure Line and Genium Line.

22

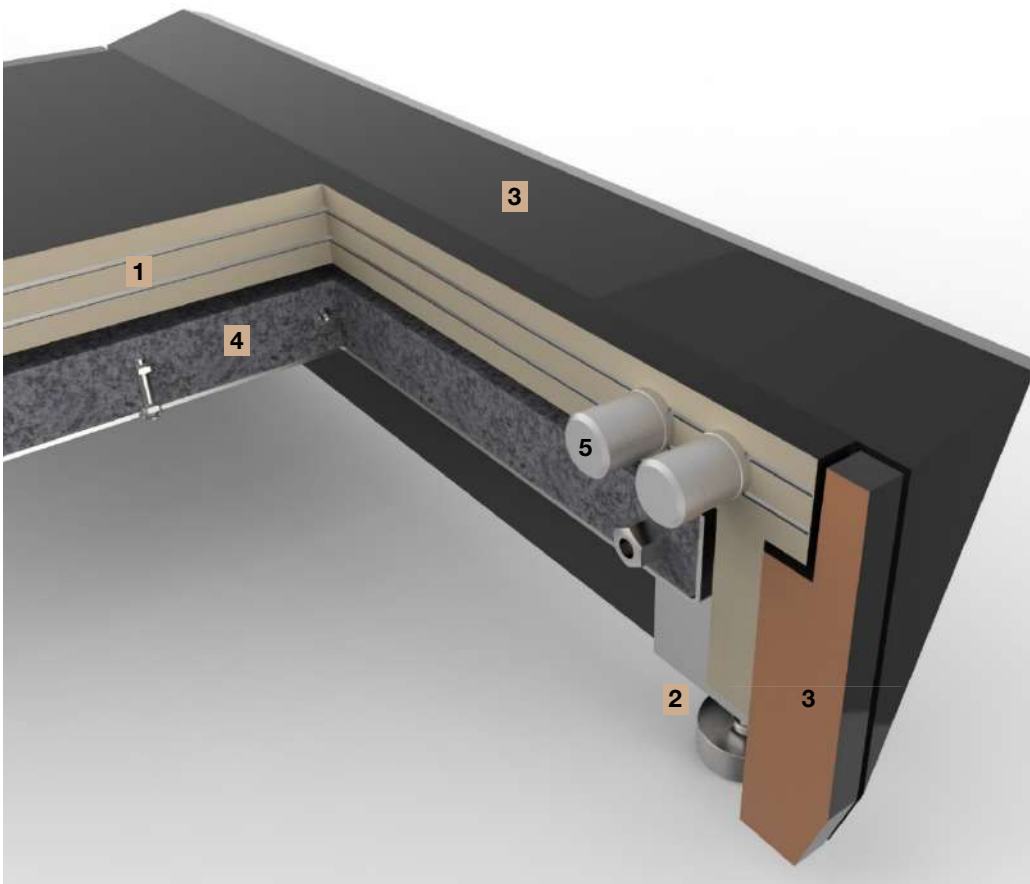

● = standard equipment ○ = available as optional equipment - = not available Explanations of the footnotes – page 32

Basic models 317

Base Line

Height in mm	Width in mm	Usable width in mm	Depth in mm	Usable depth in mm	Weight ⁴ in kg	List price ⁵ Euro excl. VAT
317 Base Line						
166	538	400	566	528	37,0	
166	698	560	566	528	47,0	
166	538	400	846	808	53,0	
166	698	560	846	808	69,0	

Standard equipment 317

Base Line

List price⁵
Euro excl. VAT.

Base Line

TECHNOLOGY

Compound-Shelves	Multi-layer structure made of MDF and aluminum with a special adhesive.		●
3D/10 Technology – vibrations decoupling	<p>For us, the art of a dynamic sound image lies in deriving micro-vibrations in the best possible way and damping them as little as possible. The new, innovative connections of the FalkenOhr shelves to the stands are all conductive for the bases. This enables the micro-vibrations generated in the shelf by the audio component to be dissipated quickly and specifically.</p> <p>Your benefit: The micro-vibrations of the electronics are dissipated in a targeted and extremely fast manner, and this leads to a highly dynamic and precise sound image.</p>		●
Stability core	<p>To drastically increase the stability and insensitivity of the bases to external vibration influences, they are equipped with their own 25 kg stabilization layer filled with damping concrete.</p> <p>Your benefit: Stiffness and high mass extend the clarity and power of the sound image once again significantly.</p>		●
Clear structure	<p>FalkenOhr bases have a clear structural separation into three main structural components. These are independently mounted and decoupled from each other.</p> <p>SOUND CORE The heart of your bases. Designed for an extremely clear, powerful, and spatial sound image.</p> <p>STABILITY CORE More mass and stiffness for more precision</p> <p>CLADDING The beautiful cover for your bases</p>		●
Decoupling of attachments	<p>All parts attached to the sound core are made of damping material on the one hand and are decoupled by a specially molded thermoplastic material as a connecting element on the other hand. This plastic, which is also used especially in mechanical engineering, is characterized by its high degree of homogeneity and thus uniform damping properties with high strength.</p>		●



Standard equipment 317

Base Line

List price⁵
Euro excl. VAT.

Base Line

Sound adjustment -
analytic/warm



Adjustment of the sound image to your acoustic preferences and conditions by adjustable damping of the spike shoes. Stone floors, certain audio components, or living room conditions can create a too hard, rigid, or even over-analytical sound. Therefore, it is possible to insert a plastic ring into the floor plate. Otherwise, the stainless-steel floor plate rests directly on the floor. The damping can be adjusted individually for each stand, and this results in a different damping/coupling for each shelf.

●

EQUIPMENT

SOUND-CORE

Stands incl. spikes
4 pcs.



Made of highly homogenous, cast aluminum EN AW-5083 in natural E6 / CO anodized.

Raw aluminum is rather soft and therefore absorbs resonances well and can distribute and transmit them very evenly due to its ordered microstructure. When the surface is finished with anodizing, a hard layer is created which makes the aluminum resistant and at the same time very conductive to sound. This enables extremely fast transmission of vibrations and resonances and at the same time a certain and desired damping. This combination cannot be found in any other material in such a balanced way.

Spikes made of stainless steel 1.4305

●

Shelf
1 pc.



Composite shelves with innovative integrated connection technology.

A shelf is conductively connected to exactly one stand and insulated with the other 3 stands, thereby vibrations from one shelf cannot influence any other shelves. This leads to the perfect transmission of the micro-vibrations created by the electronics and to the high stiffness of the sound-core

●

Spike shoes
4 pcs.



Ground plate milled out of stainless steel 1.4305. Optional plastic ring made of highly damping molded polyamide which has a high mechanical load capacity and good damping characteristics

●

Standard equipment 317

Base Line

List price⁵
Euro excl. VAT.

Base Line

STABILITY-CORE

Stainless steel tub with damping concrete
1 pc.

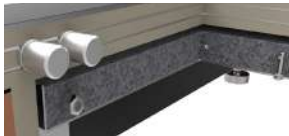

Stainless steel tub filled with highly damping concrete. Weight approx. 25 kg. Serves for a highly efficient reduction of external vibrations.

●

CLADDING

Design Crystal Cladding incl. decoupling



Made of damping MDF.

The beautiful cover for your audio furniture. Designed to complete the visual delight. Apart from the aesthetic appearance, the clarity of the sound is further enhanced due to the mass.

- Decoupled from the sound core.

●

ACCESSORIES

Assembly tools and instruction manual



Complete accessories for perfect installation and optimization of your audio furniture. Range depending on the model selected:

- 4 pcs. spike shoes
- 4 pcs. Plastic inserts for ground plate
- 1 pc. Open-end wrench 22
- 1 pc. Open-end wrench 13
- 1 pc. circular bubble
- Allen wrench
- White cotton glove
- Instruction manual

●

Optional equipment 317

Base Line

List price ⁵ Euro excl. VAT.	Base Line
--	-----------

CLADDING

Design Classic
Cladding incl. decoupling



Made of damping MDF.

The beautiful cover for your audio furniture. Designed to complete the visual delight. Apart from the aesthetic appearance, the clarity of the sound is further enhanced due to the mass.

- Decoupled from the sound core.

	○
--	---

PACKAGING

Packaging



Packed in a high-grade wooden box made of light, strength, and resistant Ceiba plywood. The lid of the box is clipped and removable.

	○
--	---

Surface finishing 317



Base Line

Extra charge⁵
Euro excl. VAT.



Base Line

SHELVES

Lacquered finishes

	Black ⁸	<input type="checkbox"/> matt G30, with a light-structure <input type="checkbox"/> semi-gloss G70		<input checked="" type="radio"/> <input type="radio"/>
	Black ⁸	<input type="checkbox"/> high gloss G100 <input type="checkbox"/> high gloss G100, polished		<input type="radio"/> <input type="radio"/>
	Arctic grey ⁸	<input type="checkbox"/> matt G30, with a light-structure <input type="checkbox"/> semi-gloss G70		<input type="radio"/> <input type="radio"/>
	Arctic grey ⁸	<input type="checkbox"/> high gloss G100 <input type="checkbox"/> high gloss G100, polished		<input type="radio"/> <input type="radio"/>

Real wood veneers

	Maple ⁸	<input type="checkbox"/> matt G30 <input type="checkbox"/> semi-gloss G70		<input type="radio"/> <input type="radio"/>
	Maple ⁸	<input type="checkbox"/> high gloss G100 <input type="checkbox"/> high gloss G100, polished		<input type="radio"/> <input type="radio"/>
	Pear ⁸	<input type="checkbox"/> matt G30 <input type="checkbox"/> semi-gloss G70		<input type="radio"/> <input type="radio"/>
	Pear ⁸	<input type="checkbox"/> high gloss G100 <input type="checkbox"/> high gloss G100, polished		<input type="radio"/> <input type="radio"/>
	Makassar replica ⁸	<input type="checkbox"/> matt G30 <input type="checkbox"/> semi-gloss G70		<input type="radio"/> <input type="radio"/>
	Makassar replica ⁸	<input type="checkbox"/> high gloss G100 <input type="checkbox"/> high gloss G100, polished		<input type="radio"/> <input type="radio"/>
	Makassar ⁸	<input type="checkbox"/> matt G30 <input type="checkbox"/> semi-gloss G70		<input type="radio"/> <input type="radio"/>
	Makassar ⁸	<input type="checkbox"/> high gloss G100 <input type="checkbox"/> high gloss G100, polished		<input type="radio"/> <input type="radio"/>
	Teak ⁸	<input type="checkbox"/> matt G30 <input type="checkbox"/> semi-gloss G70		<input type="radio"/> <input type="radio"/>

Individual surface finishing

Your desired finish ⁸ on request		<input type="radio"/>
---	--	-----------------------

Surface finishing 317





Base Line

Extra charge⁵
Euro excl. VAT
Complete Cladding











Base Line

CLADDING

Lacquered finishes

	Black ⁸	<input type="checkbox"/> matt G30 - soft touch <input type="checkbox"/> semi-gloss G70		● ○
	Black ⁸	<input type="checkbox"/> high gloss G100 <input type="checkbox"/> high gloss G100, polished		- ○
	Pure white ⁸	<input type="checkbox"/> matt G30 - soft touch <input type="checkbox"/> semi-gloss G70		● ○
	Pure white ⁸	<input type="checkbox"/> high gloss G100 <input type="checkbox"/> high gloss G100, polished		○ ○

Metallic finishes

	Silver metallic ⁸	<input type="checkbox"/> matt G30 - soft touch		○
	Silver metallic ⁸	<input type="checkbox"/> high gloss G100 <input type="checkbox"/> high gloss G100, polished		○ ○
	Arctic grey metallic ⁸	<input type="checkbox"/> matt G30 - soft touch		○
	Arctic grey metallic ⁸	<input type="checkbox"/> high gloss G100 <input type="checkbox"/> high gloss G100, polished		○ ○
	Luxor metallic ⁸	<input type="checkbox"/> matt G30 - soft touch		○
	Luxor metallic ⁸	<input type="checkbox"/> high gloss G100 <input type="checkbox"/> high gloss G100, polished		○ ○
	Crystal Red metallic ⁸	<input type="checkbox"/> matt G30 - soft touch		○
	Crystal Red metallic ⁸	<input type="checkbox"/> high gloss G100 <input type="checkbox"/> high gloss G100, polished		○ ○
	Deep Crystal Blue metallic ⁸	<input type="checkbox"/> matt G30 - soft touch		○
	Deep Crystal Blue metallic ⁸	<input type="checkbox"/> high gloss G100 <input type="checkbox"/> high gloss G100, polished		○ ○

Individual surface finishing

Your desired finish ⁸ on request		○
---	--	---

Dimensions 317

400 width

560 width

317 Base Line

Depth 528 mm

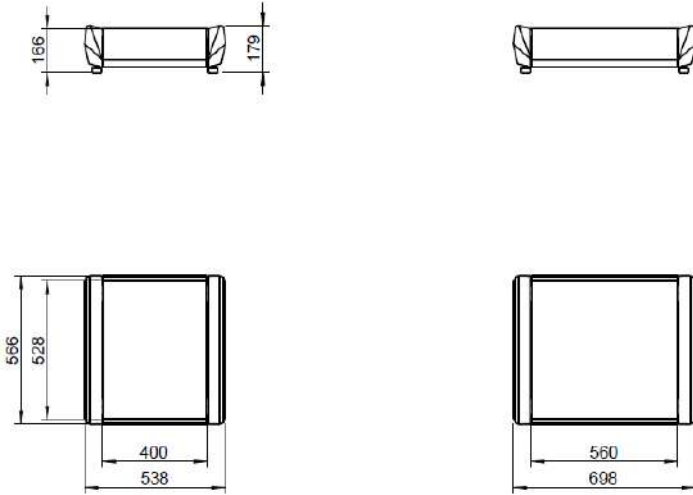

Depth 800 mm

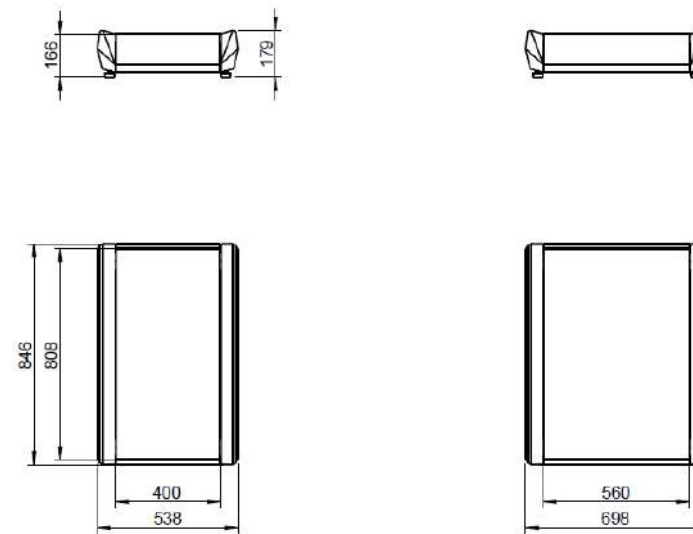

Warranty

Limited Warranty

FalkenOhr guarantees that the product designated here is free from manufacturing defects in material and workmanship for 1 year from the date of purchase by the original purchaser or no later than 2 years from the date of delivery to the authorized FalkenOhr Systems dealer, whichever occurs first, under the conditions described here.

This warranty is subject to the following conditions and limitations.

1. this warranty applies only to products purchased from an authorized FalkenOhr System Partner ("AFSP") or dealer.
2. is limited to the repair of the product neither the transport or any other costs, nor the risk of disassembly, transport and installation of the product is covered by this warranty.
3. applies only to the registered buyer and is not transferable to other persons
4. applies only to manufacturing and/or material defects that were already present at the time of purchase and not:
 - for damage and wear of the surfaces caused by normal use or exposure of the furniture to sunlight and other environmental influences
 - damage caused by unpacking, installation or improper packing
 - in case of damage resulting from use, negligence or modifications not specified in the operating instructions
 - for damage caused by defective or unsuitable additional devices
 - in case of damage caused by accidents, lightning, water, fire, heat, war, riots or any other event beyond the control of FalkenOhr and its sales organizations
 - for products, whose serial number has been changed, dropped or made unreadable
 - if repairs and modifications have been carried out by unauthorized persons
5. the product must be packed and returned to FalkenOhr or the authorized FalkenOhr system partner by the customer at his own expense. A written description of the defect and a photocopy of the original purchase receipt must be attached to a returned product. This receipt must indicate the model and serial number, date of purchase, name, and address of the buyer and the authorized dealer and the purchase price
6. FalkenOhr is in no way responsible for consequential or indirect damage or liability resulting from the use of the product discussed here or from a violation of this warranty or any implicit warranty in relation to the said product.

During the warranty period, FalkenOhr will repair or replace all defects free of charge. A Return Authorization Number (RA), which can be requested directly from FalkenOhr, is required before a product is returned to FalkenOhr or a responsible FalkenOhr System Partner for any reason. This number must be visible on the outside of the shipping package(s) for FalkenOhr or the responsible FalkenOhr system partner to accept the return. Units sent to FalkenOhr without a visible RA number on the outside of the shipping container(s) will be returned to the sender carriage unpaid. Units that are to be repaired by FalkenOhr or the responsible authorized FalkenOhr system partner must be returned by the buyer in the original packaging material and insured. A returned product should be accompanied by a written description of the defect. Repaired devices are shipped by FalkenOhr, and shipping must be paid in advance by the customer.

All other warranties or conditions either written or implied are void.

Explanations

- ¹ Klangmöbel is a term used by FalkenOhr for HiFi racks
- ² Klangbase is a term used by FalkenOhr for Amp-Stands
- ³ The information single wide, double wide and triple wide refer to electronics in 19 " design. I.e. for devices narrower than 482.6 mm, one, two, or three can be positioned side by side.
- ⁴ Weight is an approximate value without packaging and may vary slightly
- ⁵ Non-binding recommended target price in the EU
- ⁶ <https://www.blum.com/us/en/products/motion-technologies/tip-on-blumotion/overview/>
- ⁷ Available only within the EU
- ⁸ The color and structure of the images may differ from the real product
- ⁹ Drawing with intermediate profiles and pendulum flaps (optional)
- ¹⁰ Drawing with 4 pcs. shelves (3 pcs. are included in the basic price), intermediate profiles and pendulum flaps (optional)
- ¹¹ Drawing with 4 pcs. shelves (3 pcs. are included in the basic price)

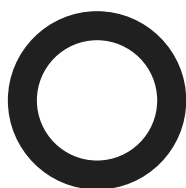

FalkenOhr

Alte Gmundner Straße 4
4655 Vorchdorf
Version: March 2022

The information on prices, extend of delivery and services correspond to the knowledge available at the time of creation. Printing errors and mistakes are reserved. All prices listed are non-binding guide prices for the EU area.